

物流學碩士學位論文

Dynamic Modeling and Analysis for Supply Chain

Supervisor

Prof. Hwan-Seong Kim

2012年2月

韓國海洋大學校 大學院

物流시스템學科

Graduate School of Korea Maritime University

Department of Logistics

Tran Xuan Thuong

物流學碩士學位論文

Dynamic Modeling and Analysis for Supply Chain

Supervisor

Prof. Hwan-Seong Kim

By

Tran Xuan Thuong



A thesis submitted in partial fulfillment of the requirements
for the degree of
Master of Engineering

In the Department of Logistics
Graduate School of Korea Maritime University

February, 2012

Acknowledgement

I would like to express my deep gratitude to my supervisor Professor Kim Hwan Seong for continuously helping and supporting me during the master course in Engineering of Logistics. His guidance, encouragement and patience have helped me to complete my study and research.

I am grateful to Prof. Kwak Kyu-Seok, Port Logistics and Social Engineering; Prof. Nam Ki-Chan, Logistics System and Transportation Planning for their detailing comments on my thesis to help me improve it.

I am also thank to Assoc. Prof. Nguyen Tan Tien, Dr. Duy Anh who gave me a opportunity to study Master course in KMU and other members in KMU for helping and sharing life with me when I was here, especially Dr. Tran Ngoc Hoang Son, Nguyen Ba Hong Anh, Tran Thanh Do, Lim Chang Won, Jo Min Ji, ...

Lastly but by no means least, I would like to thank my parents for their constant support and encouragement.

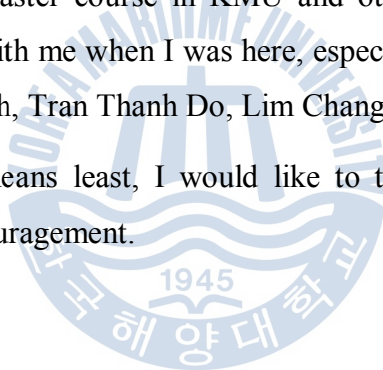

Dynamic Modeling and Analysis for Supply Chain

Tran Xuan Thuong

Department of Logistics

Graduate School of Korea Maritime University, 2011

Abstract

The objective of this study is to use system dynamics methodology to model the supply chain system and then present the optimal control to optimize the performance of supply chain by minimize the quadratic cost function while tracking and keeping the inventory close to target level. Under the system dynamics point of view, the supply chain was modeled as the continuous differential equation with lead time delay modeled as the first order delay model. In contrast to the frequency domain analysis of the classical control approach, the proposed control utilizes the time-domain state space representation with a set of input, output and state variables to build the dynamic system. On the other hand, by using the system dynamics it allows us to apply different control laws and analyze the dynamic behavior of system so that the decision policies can be found to improve the performance of supply chain. In this paper we employ the linear quadratic optimal control for such kind of supply chain dynamic system, the aim of controller is to find the control input as the order quantity to minimize the cost function and keep high customer satisfaction by tracking the target inventory level. Finally, the numerical simulation results are carried out in Matlab/Simulink

environment and the performance of optimal controller will be compared with some classical control policies such as proportional and order-up-to level control policy. It is shown that our approach can obtain some good performances.



Contents

Acknowledgement	iii
Abstract	iv
Contents.....	vi
List of Figures.....	vii
Chapter 1. Introduction	1
1.1 Background.....	1
1.2 Motivation of this research.....	3
1.3 Research objectives.....	5
Chapter 2. Supply chain management and performance measurements.....	7
2.1 Supply chain management.....	7
2.2 Structure of supply chain management	10
2.3 Performance measurement of supply chain management	13
2.4 Process in supply chain management.....	15
Chapter 3. Dynamic modeling of supply chain	21
3.1 Production model.....	21
3.2 Transportation model.....	27
3.3 Distribution model.....	29
3.4 State-space of supply chain model.....	30
3.5 Costs function of supply chain	31
Chapter 4. Controller design	33
4.1 State-space model	33
4.2 Linear Quadratic Regular control design	33
4.3 Optimal tracking controller	35
Chapter 5. Simulation results	37
5.1 Demand and control parameters.....	37
5.2 Simulation results and analysis.....	38
Chapter 6. Conclusion.....	44
References	45

List of Figures

Figure 2-1: Typical supply chain	8
Figure 2-2: Flows in supply chain	9
Figure 2-3: Five key processes in SCOR model.....	18
Figure 2-4: Eight processes of successful supply chain management [18].....	19
Figure 3-1: The production system [19].....	21
Figure 3-2: (a) Single-model case; (b) Batch-model case; (c) Mixed-model case ..	22
Figure 3-3: Single machine, single product system.....	24
Figure 3-4: Multi machine, single product system	24
Figure 3-5: Multi-product, single-stage system.....	25
Figure 3-6: Multi-product, multi-stage, parallel system	25
Figure 3-7: Fluid analogy of factory model	26
Figure 3-8: Transportation delay model.....	28
Figure 3-9: Step response of different delay models	29
Figure 3-10: Block diagram of distribution warehouse	30
Figure 3-11: Costs structure of supply chain.....	31
Figure 5-1: Customer demand	37
Figure 5-2: Simulink model of supply chain model	38
Figure 5-3: Dynamic response with proportional controller	39
Figure 5-4: Dynamic response of factory warehouse with PID controller	40
Figure 5-5: Dynamic response of factory warehouse with optimal controller.....	41

Chapter 1. Introduction

1.1 Background

Business logistics is a relatively new field of integrated management study in comparison with the traditional fields of finance, marketing, and production. Logistics adds values to products or services that are essential to customer satisfaction and sales. Logistics plays a crucial role in creating value-value for customers and suppliers of the firm, and value for the firm's stakeholders. To many firms around the world, logistics has become an increasingly important value-adding process for a number of reasons such as reducing costs and increasing sales. However, due to the rapid change in the economy and technological landscapes, the change in marketplace and the competitiveness between companies. Those major changes results in some following trends such as development of green logistics, managing total landed cost, improvement of inventory management, and the increasing of globalization in logistics fields.

Development of Green logistics is the first trend since environmental issues are nowadays one of the most important factors on the Earth due to the increasing of CO₂, gas emission and other toxic waste, ... Therefore, Green logistics is the trend to develop the efficient logistics system aims to reduce the greenhouse gas (GHG) and other toxic environmental waste. On the other hand, because of rising fuel costs and the effect of transportation to environment, it is also required to change transportation environment so that the logistics managers have to choose the transportation modes which reducing the CO₂, toxic gases and saving the energy. Green logistics will become more reliable.

The second trend is the managing total landed cost effectively. Cost is always one of the most significant criteria to measure the supply chain system. Therefore, to obtain the effective logistics system, logistics managers has to try to manage and reduce unnecessary costs in the presence of uncertainty about the economy and fuel costs.

Improvement of inventory management strategy is the third trend that logistics managers must cover. Reducing the timing and costs of inventory will be a huge focus and a better inventory strategy will leave warehouse managers with no excuses if inventory costs rise. Furthermore, enhancing the information management in supply chain system also contributes to build the effective logistics systems, thanks to Electronic data interfaces between customers and logistics providers. This helps to remove double work, speeding up processes, and reducing costs.

Finally, the increasing of globalization is an obvious trend in the world because of rapid development of global economy and the increasing competitiveness from multinational and highly specialized companies. Besides, there are other factors that logistics managers should take into account such as natural disasters and currency risks will also impact logistics system in future.

Along with the development trend in logistics, supply chain management still keeps as the key issue in a successful business of any organizations. Therefore, it is strongly necessary to realize the important of supply chain management. Supply chain are the collection of several entities such as suppliers, manufacturers, distributors and customers, that work together to convert raw materials to finished products and deliver them to end-customers. Managing the processes of supply chain is known as supply chain management. Supply chain management encompasses the planning and management of all activities includeing sourcing, procurement, logistics distribution. It also includes coordination and collaboration with channel partners such as suppliers, third party providers, customers.

Recently, due to the rapid development of the global marketplace and the large variability in products, customer demands, along with the increasing of competitiveness of companies, organizations increasingly realize that they must rely on effective supply chains to compete in the global market and networked economy. The effective and efficient supply chain management (SCM) plays an important role in achieving high profit, lower costs and better customer satisfaction in their business [1]. Furthermore, the importance of supply chain management is

expressed as reducing inventories along the supply chain, better information sharing among the partners. This leads to lower total costs and better customer service level and contributes to the effective performance of companies. By recognizing the important of supply chain management, many companies have been addressed to improve their supply chain and obtain many big goals in business such as Wal-Mart Stores, Procter & Gamble and Dell Computer Corporation.

Due to the mentioned importance of supply chain management, many researchers and managers are attracted to model, analysis and control it to look for better policies or managerial methods to improve the performance of SCM. Among those methodologies, system dynamic methodology has outstanding way to investigate on the supply chain management. In next subsection, we will present the motivation for using system dynamic to model and control supply chain.

1.2 Motivation of this research

During last half century, modeling, analysis and control of supply chain have attracted a lot of researchers. According to Beamon, approaches for modeling supply chain system can be grouped into four categories: (1) deterministic analytical models where all the parameters are known, (2) stochastic analytical models where at least one parameter is unknown but follows a probabilistic distribution, (3) economic models, and (4) simulation models [2]. The majority of these models are steady-state models based on average performance or steady-state conditions. However, static models are insufficient when dealing with the dynamic characteristics of the supply chain system, which are due to demand fluctuations, process lead-time delays, sales forecasting, etc. On the other hand, when supply chain system becomes more complex, it is difficult or sometimes cannot model the supply chain by using such kind of analytical or deterministic method. Therefore it becomes increasingly important to model the dynamic of a supply chain system in order to obtain a comprehensive understanding of the factors that have impact on system performance. The dynamic models of supply chain system have been

studied for over years, which can be categorized as follows: continuous-time differential equation models, discrete-time difference models, discrete event models and classical operational research methods [3].

Recently, due to the rapid development of marketplace and the large variability in products, customer demands, along with the increasing of competitiveness of companies. The effective and efficient supply chain management (SCM) plays an important role in achieving high profit, lower costs and better customer satisfaction in their business. However making the plan for controlling and managing inventory in supply chain has met many challenges in the presence of mentioned above factors. Therefore, it is required to employ the systematic policies for planning and control of supply chain efficiently. To deal with the issues, various alternative approaches have been proposed for modeling and control of supply chain. Among those approaches system dynamics (dynamical system) provide a convenient and compact way to model and analyze supply chain system. By using the system dynamics methodology, it allows logistics planner to bring out (initialize) the systematic decision-making processes for the supply chain as if they are controlling a dynamic system by means of control theory, [4]. Control theory provides an excellent tool to analyze, design and simulate supply chain management systems, based on dynamic models.

Next, some main research results concerning with supply chain dynamic are reviewed. A number of papers dealt with application of control theory to dynamical supply chain and production inventory systems were reviewed [1], [5]. Forrest developed a dynamic analysis and simulation of industrial systems called “industrial dynamics” approach [6]. This work was able to reproduce a major problem in supply chains, which recently known as “the bullwhip effect”. His work is based on the coupling of first-order differential equations. However, because of the complexity of the models and some limitations, this work just covered small problem in dynamic of SCM. Towill reported the inventory and order based production control system (IOBPCS) based on a transfer function analysis and classical feed-forward control [7]. This analysis can cope with changing demands,

dampen oscillations and smoothly run the system. However, the scope of this work is limited in the sense that it does not consider the manufacturing sites and analyzes only the distribution channels. Then many modifications and extensions of this model were presented and led to the IOBPCS family. These can be found in [8], [9], [10], [11]. All of these works dealt with aggregate product levels or alternatively it reflects a single product.

Perea et al. presented an integrated continuous-time approach for modeling the dynamics in supply chain management systems [12]. They apply four different heuristic control laws to evaluate the performance of supply chain system. However since those policies are only heuristic rules, the optimal solution cannot be found. To find the optimal solution for this problem, Perea employed the Model Predictive Control (MPC) to manage a multi-product, multi-echelon production and distribution network with lead times, allowing no backorders [13]. They formulated the discrete optimal control problem as a large scale mixed integer linear programming (MILP) problem. In their formulation the demand is considered to be deterministic.

Most of previous works do not concern with the integrated modeling of lead time with dynamic modeling of supply chain entities to build a systematic framework based on state space model methodology. On the other hand, just a few of those studies dealt with the optimal solution of supply chain based on system dynamic model. Therefore, in this study, a systematic modeling of supply chain will be proposed by using continuous modeling of supply entities such as factory, distribution, transportation model and lead time. Then an optimal control will be presented to find the optimal order quantities while minimize the cost function of supply chain system.

1.3 Research objectives

The objective of this study is to use system dynamics methodology to model the supply chain system and then present the optimal control to optimize the performance of supply chain by minimizing the quadratic cost function while

tracking and keeping the inventory level close to target level. Under system dynamics point of view, we can apply some control policies as if we use the control laws for dynamics systems, then the behavior of system is analyzed and evaluated to improve the performance of supply chain system.



Chapter 2. Supply chain management and performance measurements

2.1 Supply chain management

2.1.1 Definition of supply chain management

Supply chain management concept was come up with since 1980s and since 1990s, the supply chain management term become the “key word” of any logistics managers. Along with time, the concept of supply chain management was varied much. In this subsection, we will briefly present some concepts of supply chain management.

During 1950s to 1960s, supply chain focused on total system costs with the development of the physical distribution concept. The objective of studies in this period is to analyze the trade-off of good physical distribution and total system costs and focus upon physical distribution or outbound logistics.

Since 1890s, the concept of supply chain management changed with logistics or integrated logistics management concept by adding inbound logistics to the outbound logistics of physical distribution (figure 2-1). This change is logical due to deregulation of transportation and the growing of global sourcing of materials and supplies for inbound systems. From this period the value chain concept had been used for competitive analysis and strategy depend on the level of integration of marketing, sales, and manufacturing with logistics, [14].

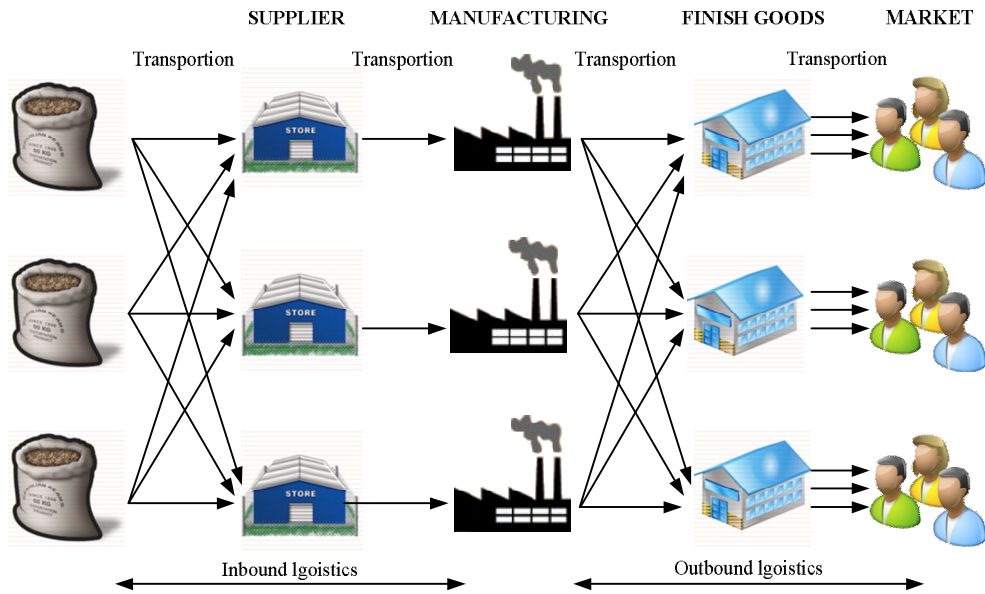

Figure 2-1: Typical supply chain

Supply chain management became more prevalent during 1990s and its important has been expressed much more in business and thus it also increases the complexity of supply chain management. At this time, a simple traditional supply chain can be defined as the synthesis of various entities such as suppliers, manufacturers, distributors, retailers and customers. They are coordinated by two-way flow of goods, information and financials as shown in figure 2-2. The first flow relates to the forward flow of materials or goods from upstream to downstream echelon. The second flow in information flow which relates to the demand or sales data information from customer/market back to the distributors, manufacturers, and suppliers. The third and final flow is financial flow concerns the movement of capital through supply chain such as payment for goods, services, or order received.

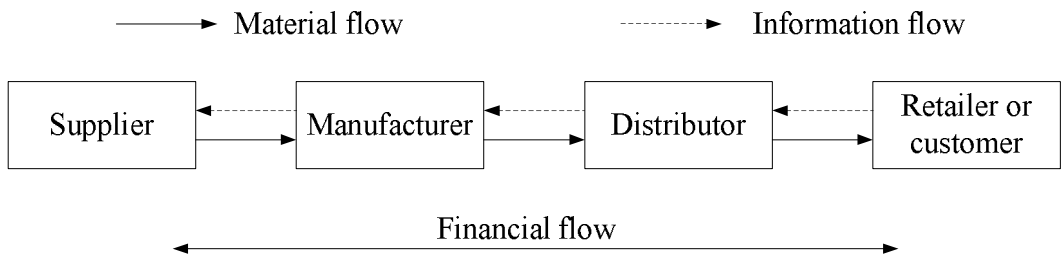

Figure 2-2: Flows in supply chain

Recently, according to the Council of Supply Chain Management Professionals (CSCMP), supply chain management encompasses the planning and management of all activities involved in sourcing, procurement, conversion, and logistics management, [15]. It also includes the crucial components of coordination and collaboration with channel partners, which can be suppliers, intermediaries, third-party service providers, and customers. In essence, supply chain management integrates supply and demand management within and across companies. More recently, the loosely coupled, self-organizing network of businesses that cooperate to provide product and service offerings has been called the Extended Enterprise.

As mentioned in chapter 1, there are several development trends in logistics development which also affect on the supply chain management, especially the globalization. These trends are globalization, increasing of cross border sourcing, collaboration for parts of value chain with low-cost providers, shared service centers for logistical and administrative functions, increasing of global operations, and finally is the complex problems in SCM. This leads to the definition of global supply chain management which faces more challenges such as large scope supply chain, the lead time is much longer, the different currencies, different tax laws, etc.

After giving some definition and perspective of supply chain management, important factors and related characteristics of supply chain management must be considered since they are keys to successful implementation of supply chain management.

2.1.2 Characteristics of supply chain management

The first characteristic of SCM is inventory visibility. Inventory management is a key factor in supply chain management and the important metric to measure the supply chain performance. Inventory level affects on the customer satisfaction via the inventory must be sufficient to meet customer demand and affects on costs via inventory holding costs. Therefore, the trade-off needs to be carried out to balance between costs and customer service level. On the other hand, inventory visibility through the supply chain is necessary to reduce safety stock as well as reduce the bullwhip effect. An effective inventory management must keep inventory low enough to minimize inventory related costs while satisfying the desired customer service level.

The second factor is cost which is another important objective of supply chain management. The companies have to consider the total costs of supply chain and attempt to optimize these costs which include production costs, inventory related costs, materials costs, logistics costs.

The third factor is information management in SCM, effective management of information sharing though supply chain play a significant role in reducing uncertain, consequently reduces safety stock and obviously lowers inventory. Another affect of information sharing is to reduce the demand and inventory amplification. However, sharing information is still complicated and difficult since there are a lot data collected every day.

Lastly, customer service is a very important attribute of successful supply chain. The management has to focus upon the customer service as a key performance metric.

2.2 Structure of supply chain management

The key success of supply chain management is how speed all the activities/functional processes can be implemented how well the customer requirements and customer satisfaction are realized. The objective of effective

supply chain management is to reduce inventory (reduce inventory related costs), to lower operation costs, increasing the product availability and customer satisfaction. The decision associated with supply chain management cover both the long-term and short-term, corresponds with strategic and operational level decision. Strategic decisions deal with corporate policies and have to look at overall of supply chain structure. Operational decisions deal with every day activities and problems of organization in considering with strategic decisions. Therefore, organization must structure the supply chain by attending much more on strategic decisions and focus on the day-to-day activities at the same time. However, marketplace demand, customer service, transportation considerations and cost elements change over time unexpectedly. Therefore, organization needs to realize these changes and structure the supply chain accordingly.

From the above perspective on structure of supply chain, there are six key elements consist in supply chain: Production, supply, inventory, location, transportation and information. They are described as following [16].

Production: Strategic decisions regarding production focus on what customers want and the market demands. This first stage in developing supply chain agility takes into consideration what and how many products to produce, and what, if any, parts or components should be produced at which plants or outsourced to capable suppliers. These strategic decisions regarding production must also focus on capacity, quality and volume of goods, keeping in mind that customer demand and satisfaction must be met. Operational decisions, on the other hand, focus on scheduling workloads, maintenance of equipment and meeting immediate client/market demands. Quality control and workload balancing are issues which need to be considered when making these decisions.

Supply: Next, an organization must determine what their facility or facilities are able to produce, both economically and efficiently, while keeping the quality high. But most companies cannot provide excellent performance with the

manufacture of all components. Outsourcing is an excellent alternative to be considered for those products and components that cannot be produced effectively by an organization's facilities. Companies must carefully select suppliers for raw materials. When choosing a supplier, focus should be on developing velocity, quality and flexibility while at the same time reducing costs or maintaining low cost levels. In short, strategic decisions should be made to determine the core capabilities of a facility and outsourcing partnerships should grow from these decisions.

Inventory: Further strategic decisions focus on inventory and how much product should be in-house. A delicate balance exists between too much inventory, which can cost anywhere between 20 and 40 percent of their value, and not enough inventory to meet market demands. This is a critical issue in effective supply chain management. Operational inventory decisions revolved around optimal levels of stock at each location to ensure customer satisfaction as the market demands fluctuate. Control policies must be looked at to determine correct levels of supplies at order and reorder points. These levels are critical to the day to day operation of organizations and to keep customer satisfaction levels high.

Location: Location decisions depend on market demands and determination of customer satisfaction. Strategic decisions must focus on the placement of production plants, distribution and stocking facilities, and placing them in prime locations to the market served. Once customer markets are determined, long-term commitment must be made to locate production and stocking facilities as close to the consumer as is practical. In industries where components are lightweight and market driven, facilities should be located close to the end-user. In heavier industries, careful consideration must be made to determine where plants should be located so as to be close to the raw material source. Decisions concerning location should also take into consideration tax and tariff issues, especially in inter-state and worldwide distribution.

Transportation: Strategic transportation decisions are closely related to inventory decisions as well as meeting customer demands. Using air transport obviously gets the product out quicker and to the customer expediently, but the costs are high as opposed to shipping by boat or rail. Yet using sea or rail often means having higher levels of inventory in-house to meet quick demands by the customer. It is wise to keep in mind that since 30% of the cost of a product is encompassed by transportation, using the correct transport mode is a critical strategic decision. Above all, customer service levels must be met, and this often times determines the mode of transport used. Often times this may be an operational decision, but strategically, an organization must have transport modes in place to ensure a smooth distribution of goods.

Information: Effective supply chain management requires obtaining information from the point of end-use, and linking information resources throughout the chain for speed of exchange. Overwhelming paper flow and disparate computer systems are unacceptable in today's competitive world. Fostering innovation requires good organization of information. Linking computers through networks and the internet, and streamlining the information flow, consolidates knowledge and facilitates velocity of products. Account management software, product configurations, enterprise resource planning systems, and global communications are key components of effective supply chain management strategy.

2.3 Performance measurement of supply chain management

Most organizations want to achieve efficiency in their operations and effectiveness in dealing with their customers but how to know the efficiency and effectiveness are. Thanks to performance measurements or metrics which will be the key factors and crucial issues for evaluating the efficiency of supply chain management system or to compare competing alternative systems. The objective of performance measure is to accomplish the monitoring, controlling and directly

logistics operations. Monitoring is to track system performance via appropriate metrics and report to managers, [14]. For example, the measuring fill-rates, on-time deliveries and logistics costs. Controlling is to modify the system to follow the desired performance. Directing relates to employee motivation and reward for performance.

There are many measures or metrics that can be used to measure performance of supply chain systems depend on different factors in SCM. Therefore knowing what specific metrics to use is also an important problem for performance measurement. However performance metrics change over time according to the complexity of supply chain, the development trend in logistics supply chain. For example, the metrics can vary from the customer service level to the total costs metric, etc and the supply chain manager needs to use multiple measures rather than a single measure to determine the performance.

To decide which performance measure used, it is needed to provide some characteristics of good measurement. Because of the variety of performance metrics, useful guidelines should be pointed out as following to help the logistics and supply chain managers:

- Since there are a lot of performance measures for logistics and supply chain management, companies need to choose several metrics which are suitable and significant to evaluate their supply chain management system.

- The performance measures must focus upon customer factor and company's expectations as well as upon several key processes in their SCM such as planning, sourcing, manufacturing and fulfilling.

- Note that an important measurement in supply chain is cost, so an accurate cost measurement will contribute to the advantage competitiveness of each company.

- Today, the rapid development of technology also provides a powerful tool for companies to enhance efficient performance measurement of supply chain.

After introducing to performance measurement and its importance in supply chain management, we need to classify performance measures into some categories.

Unlike the tradition metrics, supply chain metrics have to focus upon common processes in supply chain: plan, source, make, deliver and return to evaluate the supply chain performance [14]. According to [2], these performance measurements can be categorized as either qualitative or quantitative.

Qualitative performance measures relate to customer satisfaction, flexibility (the ability of supply chain can respond to random fluctuations in demand), information and material flow integration and effective risk management.

Quantitative performance measures may be classified in two categories: objectives based on cost or profit and objectives based on customer responsiveness. Based on cost, the measures relate to minimizing total costs (costs of materials, transportation costs, inventory related costs, material handling costs and other indirect costs), maximizing sales or profit and return on investment. Meanwhile, based on customer responsiveness, the measures relate to fill rate, perfect order fulfillment (percentage of orders delivered on time and in full), order fulfillment lead time (time between placing an order and receiving it).

2.4 Process in supply chain management

As mentioned in previous section, supply chain consists of functional activities that acquire raw materials from supplier, convert to finished products and finally deliver to end-customers. Traditionally, supply chain management managed separately their processes such as ordering process, replenishment process, manufacturing process, and procurement process. These processes shown as in figure 2-1

Ordering process includes a number of activities in the customer order cycle. Specifically, they include order preparation, order transmittal, order entry, order filling and order status reporting. The ordering process will be finished after the elapsed time between the time a customer order, purchase order, or service request is placed and the time it is received by customer.

Order preparation concern the activities of gathering information of requested product or service. (Note that depend on the interaction in supply chain, order signal can come from the customer to retailers/manufacturers or from retailers to distributors/manufacturers or from manufacturers to suppliers). This activity can be enhanced for faster processing by electronic technologies such as bar code scanning, using computers, electronic data interchange (EDI) technology and RFID. Then the order can be transferred to place for handling it by manually (physical carrying) or electronically (mail of order). Next activity is order entry which includes variety of tasks: checking item, number, quantity, and price; checking the availability of item in stock; preparing backorder or order cancellation; transcribing the order and finally is billing. In the next step, order is filled and sent to customers, this activity may involve: acquire the items through stock retrieval, production or purchasing; packing of shipment; schedule the shipment for delivery and prepare the shipment documentation. Finally, order received and order status is reported, [17].

The second process is replenishment process which usually occurs at the retailers/distributors or suppliers. The replenishment process is almost similar to ordering process except that it is triggered by customer demand, it means that when the retailers/distributors fill customer demand, their inventory is depleted and must be replenished to meet future demand. The process depends on the replenishment policy that retailers/distributors applied to satisfy some specific objectives such as minimizing costs or high customer satisfaction.

Manufacturing process is the third process which triggered by customer orders, replenishment orders from a retailer or distributor or by the demand forecast and current availability in manufacturing warehouse. Manufacturing process can operate as pull (reacting to customer demand) or push (reacting to anticipating customer demand) process or hybrid pull/push process. The activities in manufacturing process include order arrival, production scheduling and planning, manufacturing and shipping, order received reports. When order occurs, the

production scheduling must be set with allocating a production plan that gives production quantities for each product, and decide the approximate production sequence. Then the manufacturing process will be carried out and finished products are shipped to customers. Finally, the order received signal is reported.

The last process in supply chain is the procurement process which occurs at the manufactures/suppliers. This process is to acquire raw materials for manufacturing process. The procurement process is also similar to the above processes however the order quantities follow to the production schedule.

The managing individual functions/processes as mentioned above is no longer meet the changes in business environment due to rapid changes in marketplace demand, shrinking of resources, globalization trend, the increasing of collaboration and coordination. Therefore, a successful supply chain management has to integrate all of individual activities/functions into common management processes in SCM. Supply chain management process integration involves collaborative work between buyers and suppliers, joint product development, common systems and shared information. By understanding the supply chain management processes and how they are implemented and integrated, supply chain managers can lead to achieve their goals in business such as higher revenue or increasing of profit and higher customer satisfaction.

According to the Supply Chain Operations Reference (SCOR) model [14], there are five key process integrations for supply chain managements shown in figure 2-3: plan, source, make, deliver, and return.

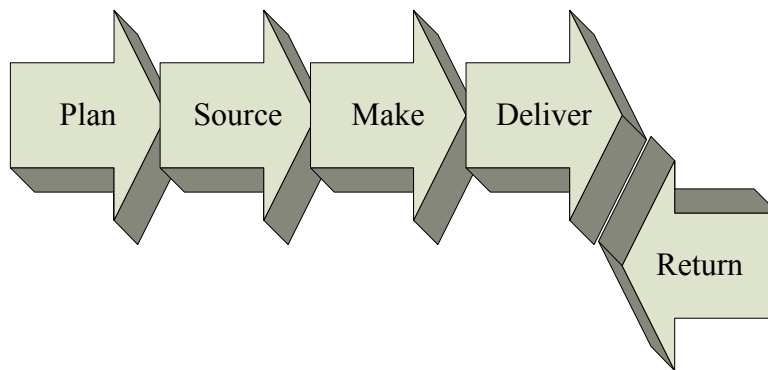

Figure 2-3: Five key processes in SCOR model

The plan process involves demand and supply planning and management. The planning would cover supply chain performance, data collection, inventory, capital assets and transportation, etc. The objective is to develop a course of action which best meets sourcing, production, and delivery requirements.

The source process encompasses sourcing stocked, make-to-order and engineering-to-order products and materials. The source process covers managing the source business rules, assessing supplier performance, and maintaining appropriate data, as well as managing inventory, capital assets, incoming product and supplier agreements, etc.

The make process comprises make-to-stock, make-to-order, and engineering-to-order production. The process covers scheduling production activities, issuing product, producing and testing, packaging, staging and releasing. Essentially, those processes transform raw materials or semi-finished products to finished products to meet planned or actual demand.

The deliver process involves ordering, warehousing, transporting, installation of stocks, and distributing products. It covers all order management activities, warehousing activities, invoicing, and managing transportation.

The return process encompasses the return of raw materials (to suppliers) and receipt of finished goods (from customers) .

While there are five key processes in SCOR model, according to [18], eight processes shown in figure 2-4 need to be managed and integrated for successful supply chain management.

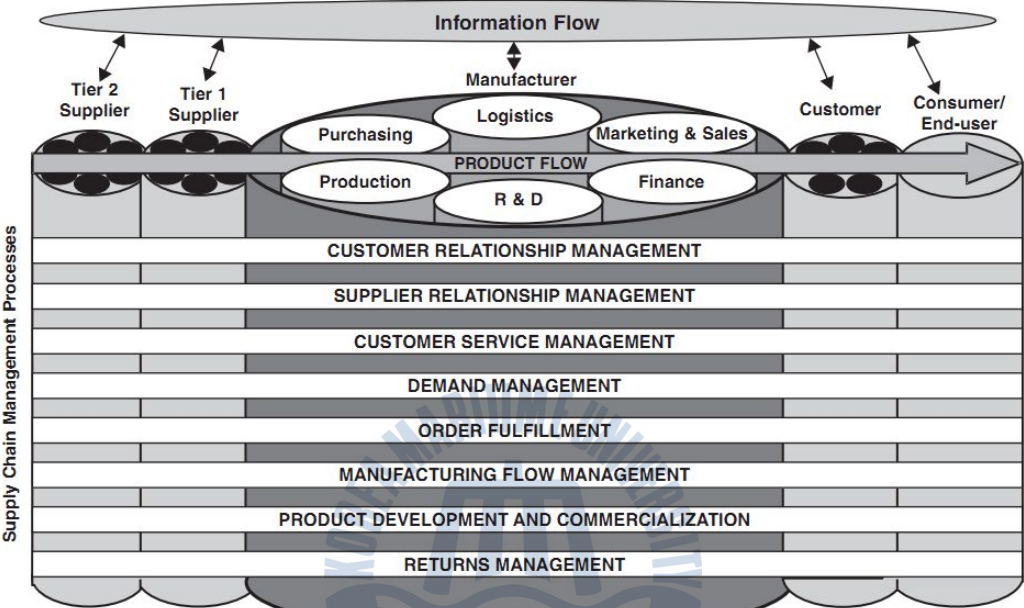

Figure 2-4: Eight processes of successful supply chain management [18]

Customer relationship management process concerns the relationship between organization and its customers, how these relationships will be developed and maintained. The process need to identify key customers and customer groups to be targeted by firm, evaluate their value over time and maintain the loyalty of key customers by providing customized products and services.

Supplier relationship management process deals with the relationship between organization and supplier. Based on the value that suppliers provide to organization over time, management need to create a close relationship with small subset of suppliers and support the manufacturing flow management process and the development of new products. The desired outcome is a win-win relationship where both parties benefit.

Customer service management deals with the administration of the customer relationship management process so that it aims to solve problems before they affect the customer.

Demand management process aims to balance the customers' requirements with the capacities of the supply chain. The process not only concerns with forecasting but includes synchronizing supply and demand, increasing flexibility, and reducing variability. Demand management process coordinates with marketing and production plans to reduce uncertainty in demand.

Order fulfillment process involves filling orders, designs a network and to enable a firm to meet customer requests while minimizing the total delivered cost. The objective is to develop a seamless process from the various customer segments to the organization and then on to its suppliers.

Manufacturing flow management process concerns the production of goods and supplies to the distribution channels. Furthermore, manufacturing processes must be flexible to respond to market changes and must accommodate mass customization. Also, changes in the manufacturing flow process lead to shorter cycle times, meaning improved responsiveness and efficiency in meeting customer demand.

Product development and commercialization process integrates with customers and suppliers to develop and bring products to marketplace. Due to the shortening product life cycles, the appropriate products must be developed and successfully launched in shorter time to remain competitive. The process must coordinate with customer relationship management, select materials and suppliers in conjunction with procurement and develop production technology to manufacture and implement the best products for marketplace.

Returns management process involves activities concern with returns, reverse logistics, avoidance in the firm. The purpose of this process in not only to manage the reverse product flow efficiently, but to reduce unwanted returns, costs, and control reusable assets, increase revenue.

Chapter 3. Dynamic modeling of supply chain

3.1 Production model

3.1.1 Definition

In chapter 2, we have mentioned that the structure of supply chain consists of six key components. And in this section, the first key component of supply chain, production system, will be presented. The large and general production system was shown in figure 3-1. But in the scope of present work, we will not investigate deeply on such kind of large production system, instead, we address the basic and important system in production system, the manufacturing system. First, an overview of manufacturing systems and model will be given to have an overall perspective about manufacturing systems and then a specific production/manufacturing system used in this work is focused and modeled more detailed.

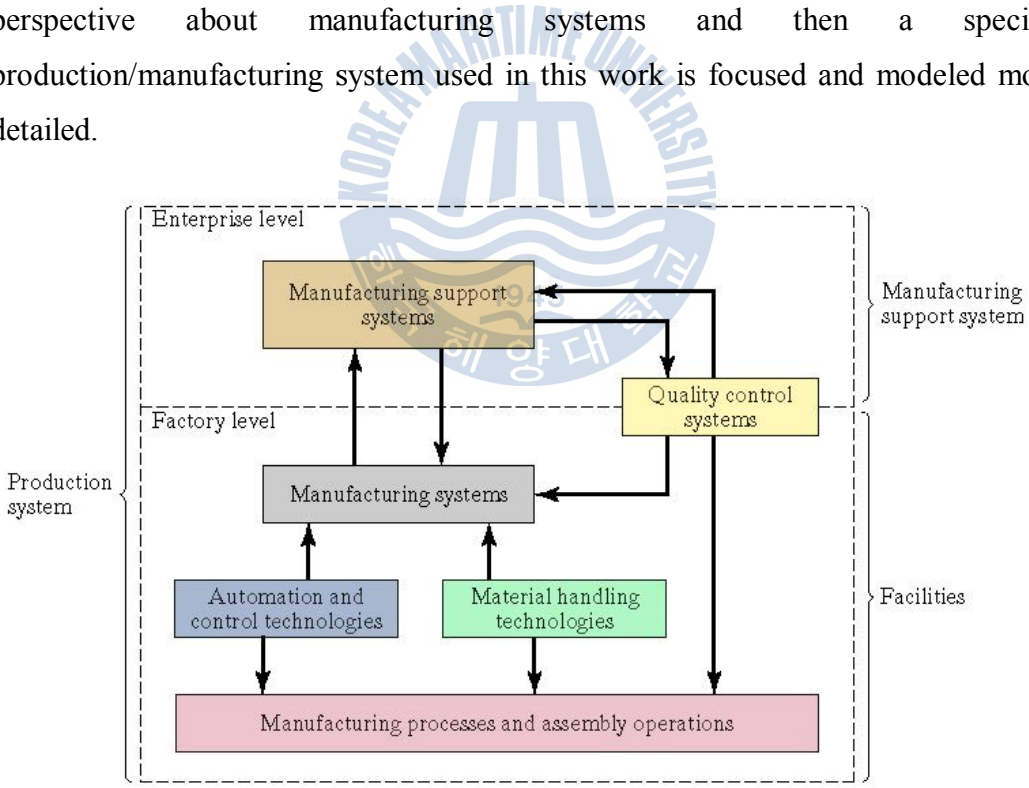

Figure 3-1: The production system [19]

According to [19], manufacturing system is a collection of integrated equipment and human resources, whose function is to perform one or more processing and/or assembly operations on a starting raw materials, parts or

products, or set of parts. There are certain basic activities that must be carried out in a factory to convert raw materials into finished products. These are: processing and assembly operations (machine), material handling, inspection and test, coordination and control.

Production operations in the process industries and the discrete product industries can be divided into continuous production and batch production. The differences are shown in figure 3-2. Continuous production means that the process is carried out on a continuous stream of material, with no interruptions in the output flow, as suggested by figure 3-2a. Meanwhile, batch production occurs when the materials are processed in finite amounts or quantities. The finite amount or quantity of material is called a batch in both the process and discrete manufacturing industries.

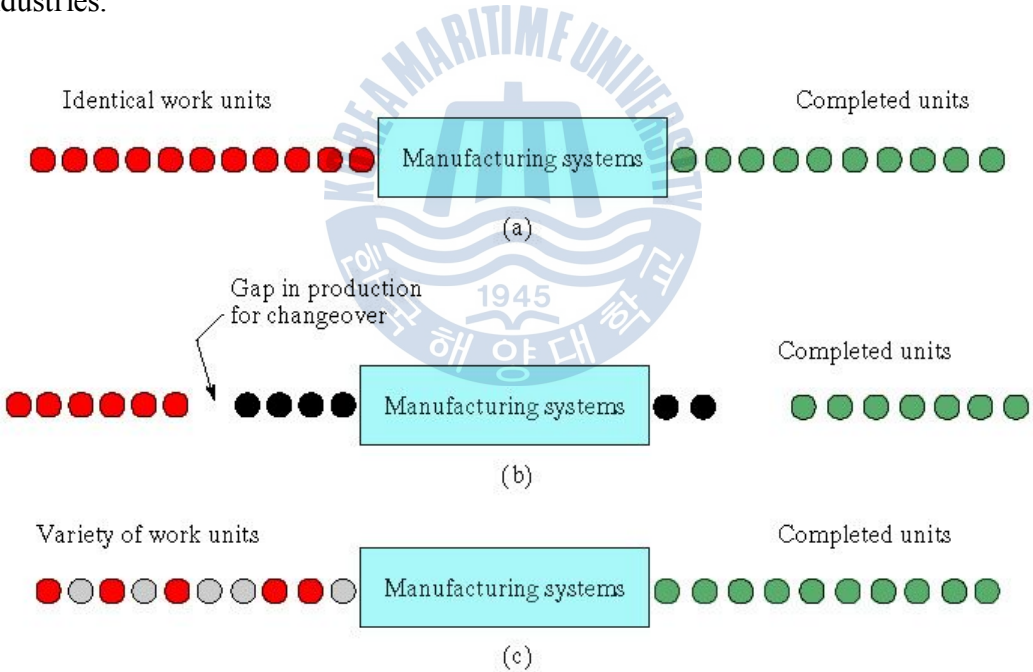

Figure 3-2: (a) Single-model case; (b) Batch-model case; (c) Mixed-model case

In the manufacturing system, there are some important properties need to be covered such as lead time, work-in-progress, production capacity, production rate, and buffer storage are introduced.

3.1.2 Classification of production model

According to [19], the manufacturing systems are classified based on five factors: (1) types of operations performed, (2) number of workstations, (3) system layout, (4) Automation and manning level, and (5) part or product variety. Based on those factors, the manufacturing systems can be distinguished into the following systems:

- Single-station manufacturing cells
- Manual assembly lines
- Automated production lines
- Automated assembly systems
- Cellular manufacturing
- Flexible manufacturing systems

However, in the scope of this work, we mention about classification of manufacturing systems based on second factor and fifth factor and also the serial or parallel properties of systems are considered. Therefore, some considered manufacturing system are as follow:

- Single-product, single-stage
- Single product, multi-stage, serial system
- Multi-product, single stage
- Multi-product, multi-stage, parallel system

3.1.2.1 Single-product, single-stage system

The single-product, single-stage manufacturing system is depicted in figure 3-3. The system consists of a machine for processing input materials $u(t)$ and converting to products which will be stored in the buffer and these products are the production inventory of system $I(t)$. The machine needs the production lead time L (includes setup time and processing time) to produce parts.

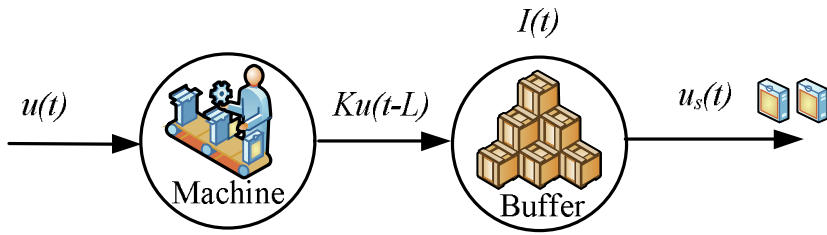

Figure 3-3: Single machine, single product system

3.1.2.2 Single-product, multi-stage, serial system

Consider single-product, multi-stage, serial system in figure 3-4, the manufacturing system consist of n machines and $I_n(t)$ is the number of products produced by the manufacturing system at time t . $u_i(t)$ is the input to machine i^{th} ($i = 1, 2, \dots, n$).

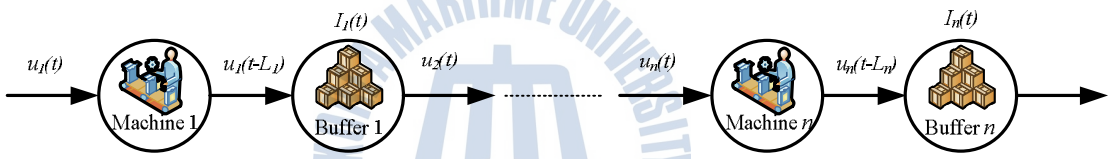

Figure 3-4: Multi machine, single product system

3.1.2.3 Multi-product, single-stage system

A multi-product, single-state manufacturing system considered in figure 3-5, in this system the machine can produce several products, for example product A,B,C,...,N. But only one product can be processed at a time. Each product has its own processing time, yield, and associated production costs.

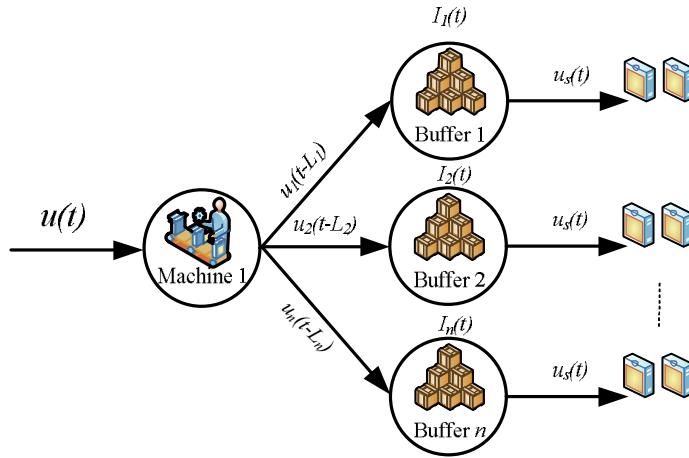

Figure 3-5: Multi-product, single-stage system

3.1.2.4 Multi-product, multi-stage, parallel system

A multi-product, multi-stage, parallel manufacturing system considered in figure 3-6 consisting of m production lines and n machines on each line which produces specific products.

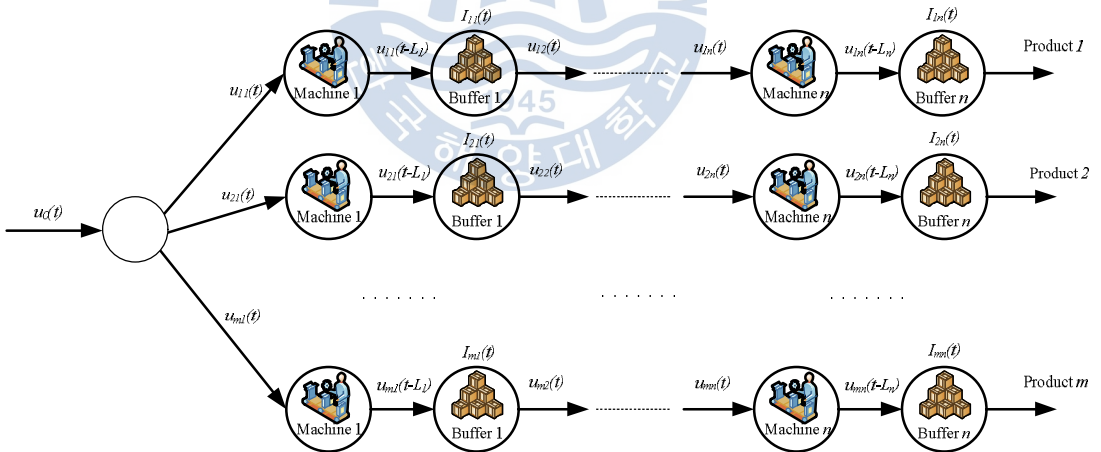

Figure 3-6: Multi-product, multi-stage, parallel system

3.1.3 Dynamic modeling of production model

In this section, we apply the fluid analogy methodology to model the dynamic of manufacturing system [20]. To produce products the factory need the setup time θ to prepare for production process and products will be finished after the production lead time L_1 (total lead time is $L = \theta + L_1$). In order to create a factory model realistically, we model the setup time delay and production lead time as pure delay and first order delay model respectively. The fluid analogy representation of factory model was shown in figure 3-7, the inventory and work-in-progress (WIP) are considered as materials stored in “tank” and in the pipe, respectively. The “tank” is replenished products from the factory after the production lead time L .

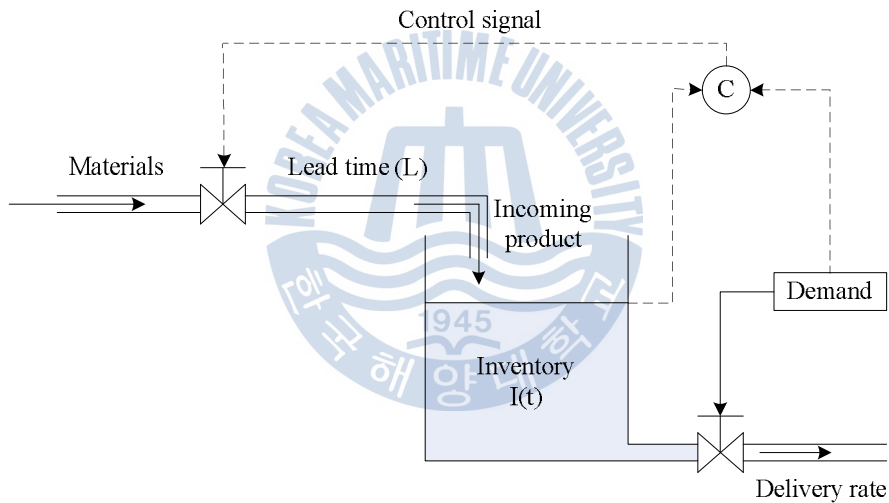

Figure 3-7: Fluid analogy of factory model

$I(t)$	Inventory of product at factory warehouse
p_c	Amount of finished products received into the factory inventory after production lead time
$p_o(t - L)$	Order production before lead time
$d(t)$	Demand signal
L_1	Production lead time
θ	Setup time

Figure 3-7 describe the representation of dynamic of single stage or single workstation in manufacturing system. The dynamic equation of this single workstation is as follow:

$$\dot{I}(t) = p_C(t) - d(t) \quad (3-1)$$

$$p_C = p_O(t - L_1) \quad (3-2)$$

The dynamic equation (3-2) can be written as below with the first order delay model:

$$\dot{p}_C = -\frac{1}{\tau_p} p_C + \frac{1}{\tau_p} p_O \quad (3-3)$$

Where τ_p is the process lead time.

3.2 Transportation model

3.2.1 Description and the important of transportation system

Transportation system move goods or products from one place to another place. According to Ballou [], there are five basic transportation modes: water, rail, truck, air and pipeline. These five modes may be used in combination (e.g., piggyback or container movement) or used as a single transportation mode. The selection of transportation modes need to balance between the quality of service offered and the cost of that service.

Since the costs of freight movement absorb between one-third and two-thirds of total logistics costs, an effective transportation system plays an important role in the logistics system. Creating greater competition is the first contribution of an efficient and inexpensive transportation system in a sense of helping to extend the marketplace by reducing the landed costs for products so that it can compete with other products selling in the same marketplaces. The second effect is contributing to the economies of scale and finally it contributes to reduce product prices.

Transportation costs depend on the choice of transportation services such as single service or intermodal services or shipment services because each service has different cost characteristics. A transportation service incurs a number of costs such as labor, fuel, maintenance, terminal, roadway, administrative, and others. These costs can be divided in to variable costs (varying with service or volume) and fixed costs.

3.2.2 Dynamic modeling of transportation system

Under the dynamic modeling point of view, the transportation system can be modeled as the first order delay model as shown in figure 3-8

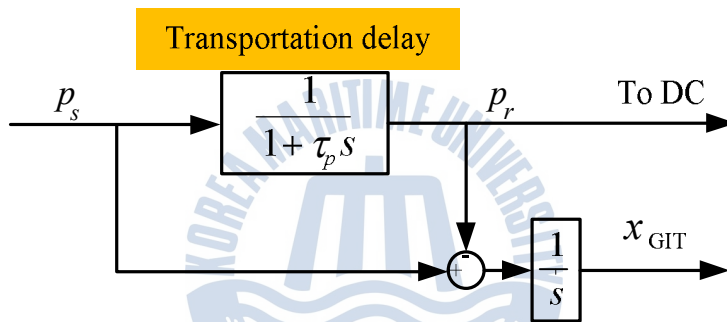

Figure 3-8: Transportation delay model

where,

p_s Amount of shipping products

p_r Amount of received products after transportation delay time

x_{GIT} Good in transit

τ_s Parameter of first order delay model (process time)

The dynamic equation of transportation model is as follow:

$$\dot{p}_r = -\frac{1}{\tau_s} p_r + \frac{1}{\tau_s} p_s \quad (3-4)$$

Actual Goods-In- Transit (GIT) equation:

$$\dot{x}_{GIT} = p_s - p_r \quad (3-5)$$

Simulation of transportation time delay model (process time $\tau_s = 6$) shown in figure 3-9.

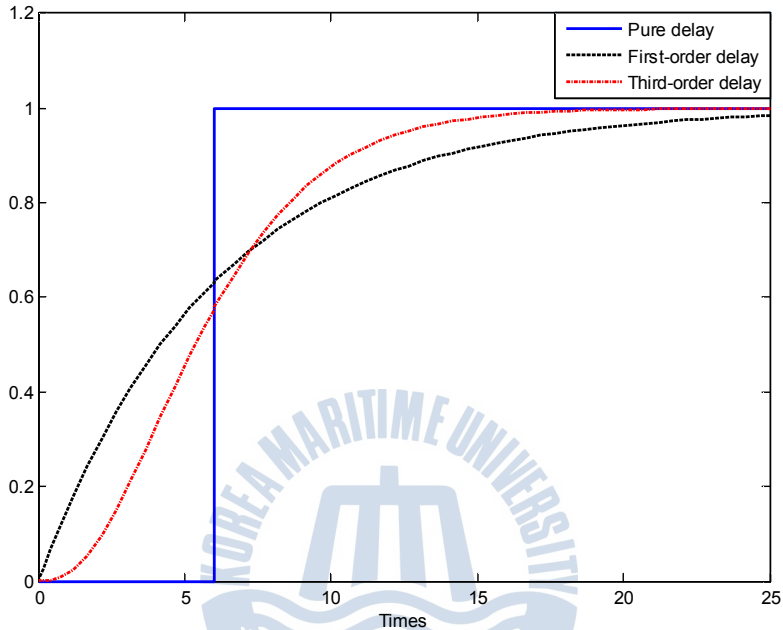

Figure 3-9: Step response of different delay models

3.3 Distribution model

3.3.1 Description of distribution model

The basic element of distribution model is the warehouse that performs several function including receiving goods from a source or manufacturing plant (factory), storing the goods until they are required, then picking the goods when they are required and shipping them to the appropriate customers.

The distribution model in this study consists of two warehouses: factory warehouse stores products/goods produced by factory and distribution which stores finished goods and ships them to customers.

3.3.2 Dynamic modeling of distribution model

The block diagram of distribution warehouse is shown in figure 3-10. The inventory level of distribution center is equal to p_r , the products received from the factory warehouse minus to the customer demand. The dynamic equation of distribution center model is given as:

$$\dot{I}_{dc}(t) = p_r - d(t) \quad (3-6)$$

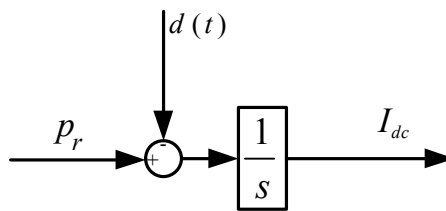

Figure 3-10: Block diagram of distribution warehouse

$I_{dc}(t)$ Inventory at distribution warehouse

p_r Amount of received products to distribution warehouse

$d(t)$ Demand signal

3.4 State-space of supply chain model

From equations (3-1), (3-3), (3-4), (3-5), (3-6) we define state variables, control inputs, reference inputs and disturbance.

- State variables: $[I(t), p_c, p_r, x_{GIT}, I_{dc}]^T = [x_1, x_2, x_3, x_4, x_5]^T$

x_1 Inventory at factory warehouse

x_2 Completed production rate

x_3 Received products at distribution warehouse

x_4 Goods-In-Transit

x_5 Inventory at distribution warehouse

- Control inputs: $[p_o, p_s] = [u_1, u_2]$

u_1 Production order to factory

u_2 Amount of products to be shipped

- Reference input: target inventory
- Disturbance:

$d(t)$ Customer demand

State space model: $(S): \begin{cases} \dot{x} = Ax + Bu + Dw + B_0r \\ y = Cx \end{cases}$

$$A = \begin{bmatrix} 0 & 1 & 0 & 0 & 0 \\ 0 & -\frac{1}{\tau_p} & 0 & 0 & 0 \\ 0 & 0 & -\frac{1}{\tau_s} & 0 & 0 \\ 0 & 0 & -1 & 0 & 0 \\ 0 & 0 & 1 & 0 & 0 \end{bmatrix}, B = \begin{bmatrix} 0 & -1 \\ \frac{1}{\tau_p} & 0 \\ 0 & \frac{1}{\tau_s} \\ 0 & 1 \\ 0 & 0 \end{bmatrix}, D = \begin{bmatrix} 0 \\ 0 \\ 0 \\ 0 \\ -1 \\ 0 \end{bmatrix}, C = \text{eye}(5)$$

3.5 Costs function of supply chain

The costs structure of supply chain is show in figure 3-11, they include inventory holding cost, backorder cost, production cost and transportation cost.

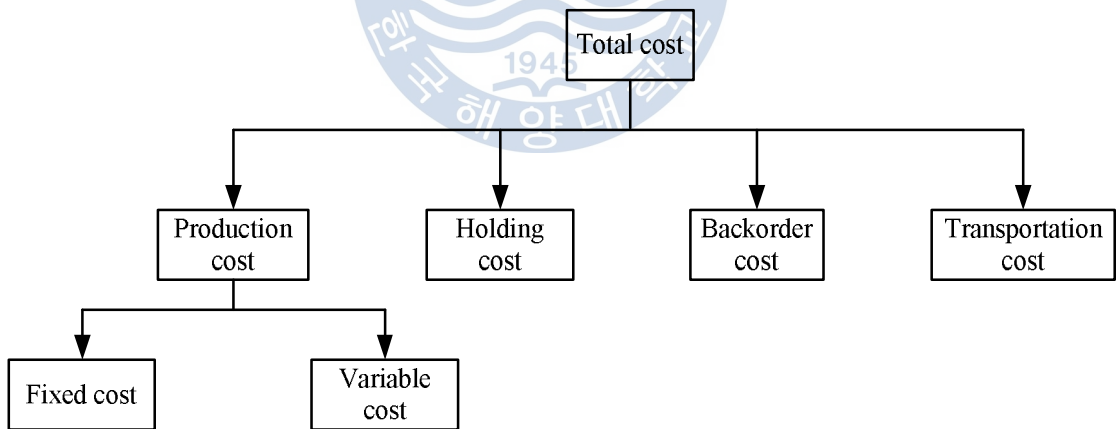

Figure 3-11: Costs structure of supply chain

- Inventory holding cost is defined as the cost which system has to incur to store products (or materials) in the distribution warehouse or factory warehouse
- Backorder cost: if the inventory is not sufficient to fulfill the customer demand, surplus demand is backorder and the backorder cost in then charged.

- Production cost includes fixed setup and variable costs. The fixed setup cost is independent of the amount of production and is incurred just for starting the manufacturing of a product. The variable cost is proportional to the amount of product to be produced.

- Transportation cost is defined as the cost to deliver the products to the customer. This cost depends on the kind of transportation (rail, truck, ship, ...) and time to deliver. In this case, we choose the truck for transportation.

The cost function is given as follow

$$TC = h(I + I_{dc}) + b(BQ_f + BQ_{dc}) + t_c \cdot x_{GIT} + f_{pc} \alpha + v_{pc} P_o \quad (3-7)$$

h Inventory holding cost (\$/item/time)

b Backorder cost (\$/item/time)

c_t Transportation cost (\$/item)

f_{pc} Fixed production cost (\$)

v_{pc} Variable production cost (\$/item)

BQ_f, BQ_{dc} Backorder quantities at factory and distribution center, respectively

α Equals to 1 when the factory start to produce products and equals to 0, otherwise

Chapter 4. Controller design

4.1 State-space model

In this section, we will consider the linear state space model given as follow

$$\begin{cases} \dot{x}(t) = Ax(t) + Bu(t) + Dw(t) \\ y(t) = Cx(t) \end{cases} \quad (4-1)$$

where

$x(t) \in R^n$, $u(t) \in R^m$, $y(t) \in R^p$ are the state, the control input and the output respectively.

A, B, C, D are constant matrices with appropriate dimensions.

$w(t)$ is the disturbance

4.2 Linear Quadratic Regular control design

We consider the linear time-invariant system as following

$$\dot{x}(t) = Ax(t) + Bu(t) \quad (4-2)$$

where $x(t) \in R^n$, $u(t) \in R^m$ with associated quadratic performance index

$$J = \frac{1}{2} x^T(T)S(T)x(T) + \frac{1}{2} \int_{t_0}^T (x^T(t)Qx(t) + u^T(t)Ru(t))dt \quad (4-3)$$

The control problem is to find the control $u(t)$ on $[t_0, T]$ subject to the dynamic constraint of system (3.7) that minimizes the performance index (3.8). We assume that the final time T is fixed and known, and no function of the final state ψ is specified. The initial plant state $x(t_0)$ is given. Weighting matrices $S(T)$ and Q are symmetric and positive semi-definite, and R is symmetric positive definite, for all $t \in [t_0, T]$.

The optimal control can be derived as follows:

Define the Hamiltonian as

$$H(t) = \frac{1}{2} (x^T Q x + u^T R u) + \lambda^T (Ax + Bu) \quad (4-4)$$

where $\lambda(t) \in R^n$ is the Lagrange multiplier. The state and costate equations are

$$\dot{x} = \frac{\partial H}{\partial \lambda} = Ax + Bu \quad (4-5)$$

$$-\dot{\lambda} = \frac{\partial H}{\partial x} = Qx + A^T \lambda \quad (4-6)$$

and the stationary condition is

$$0 = \frac{\partial H}{\partial u} = Ru + B^T \lambda \quad (4-7)$$

Solving (4-7) yields the optimal control in terms of the costate

$$u(t) = -R^{-1}B^T \lambda(t) \quad (4-8)$$

So the state x satisfies

$$\dot{x} = Ax - BR^{-1}B^T \lambda, \quad x(t_0) = x_0 \quad (4-9)$$

Using (4-9) in the state equation yields the following two-point boundary-value problem

$$\begin{bmatrix} \dot{x}(t) \\ \dot{\lambda}(t) \end{bmatrix} = \begin{bmatrix} A & -BR^{-1}B^T \\ -Q & -A^T \end{bmatrix} \begin{bmatrix} x \\ \lambda \end{bmatrix}, \quad \begin{matrix} x(t_0) = x_0 \\ \lambda(T) = Sx(T) \end{matrix} \quad (4-10)$$

This problem can be solved by several different approaches, for example, the transition matrix method, Riccati equation approach and dynamic programming.

Free-final-state and closed-loop control

Now, we will consider the case in which the final state is free and its value can be varied in the optimization process. The state and costate equation (4-9) and (4-10) are rewritten as

$$\dot{x} = Ax - BR^{-1}B^T \lambda \quad (4-11)$$

$$\dot{\lambda} = Qx + A^T \lambda \quad (4-12)$$

The control input is

$$u(t) = -R^{-1}B^T \lambda \quad (4-13)$$

By using Riccati equation approach (sweep method), the solution of the two-point-boundary-value problem can be solved as

$$\lambda(t) = S(t)x(t) \quad (4-14)$$

where $S(t)$ is the solution of matrix Riccati equation

$$\dot{S} = A^T S + SA - SBR^{-1}B^T S + Q, \quad t \leq T \quad (4-15)$$

In terms of the Riccati equation solution, the optimal control is given by

$$u(t) = -R^{-1}B^T Sx(t) \quad (4-16)$$

or

$$u(t) = -K_r(t)x(t) \quad (4-17)$$

where

$$K_r(t) = -R^{-1}B^T S(t) \quad (4-18)$$

4.3 Optimal tracking controller

The objective of optimal trajectory tracking system is to find the control input $u(t)$ to make the output vector of system follow the desired trajectory vector $r(t)$ over a specified time interval $[t_0, T]$ while minimizing the finite-time quadratic cost function

$$J(t_0) = \frac{1}{2} [Cx(T) - r(T)]^T P [Cx(T) - r(T)] + \frac{1}{2} \int_{t_0}^T \{ [Cx(t) - r(t)]^T Q [Cx(t) - r(t)] + u^T R u \} dt \quad (4-19)$$

According to [21], the solution for the LQ tracking with disturbance is given as below:

$$u(t) = -K(t)x(t) + R^{-1}B^T v(t) \quad (4-20)$$

where $K(t)$ is the control gain and $v(t)$ is the auxiliary function are given as:

$$K(t) = R^{-1}B^T S(t) \quad (4-21)$$

$$-\dot{v}(t) = (A - BK)^T v(t) + S(t)w(t) \quad (4-22)$$

And $S(t)$ is the solution of the Riccati equation:

$$-\dot{S}(t) = A^T S(t) + S(t)A - S(t)BR^{-1}B^T S(t) + Q \quad (4-23)$$



Chapter 5. Simulation results

5.1 Demand and control parameters

To verify the proposed model and controller, several numerical simulations were carried out with some demand patterns show in figure 5-1. The demand includes constant demand, step demand and impulse demand with average demand is 50 units, the inventory target is 80 units. The simulation parameters are:

- Setup time (dead time): 3 days
- Production lead time (first order): 6 days
- Demand: 50 units
- Simulation time: 100 days
- Target inventory level: 80 units

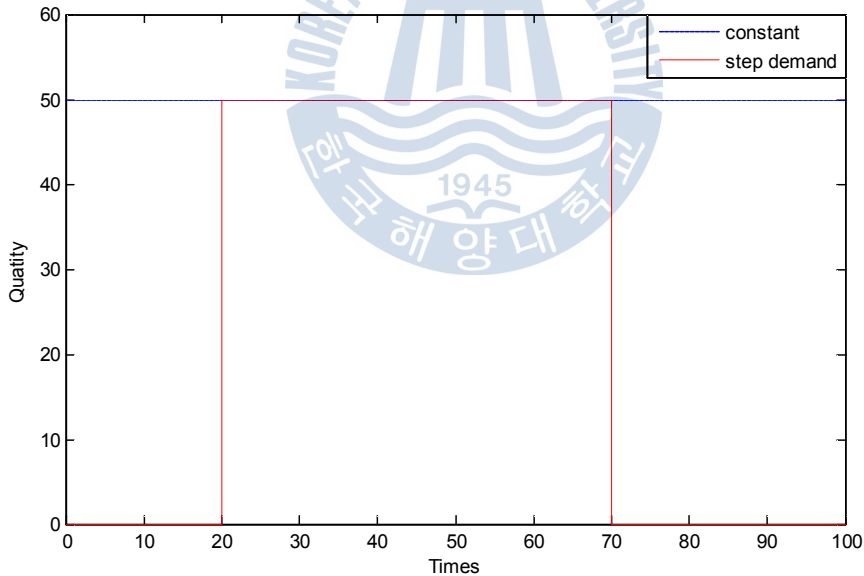

Figure 5-1: Customer demand

The supply chain model was built in Matlab/simulink as in figure 5-2

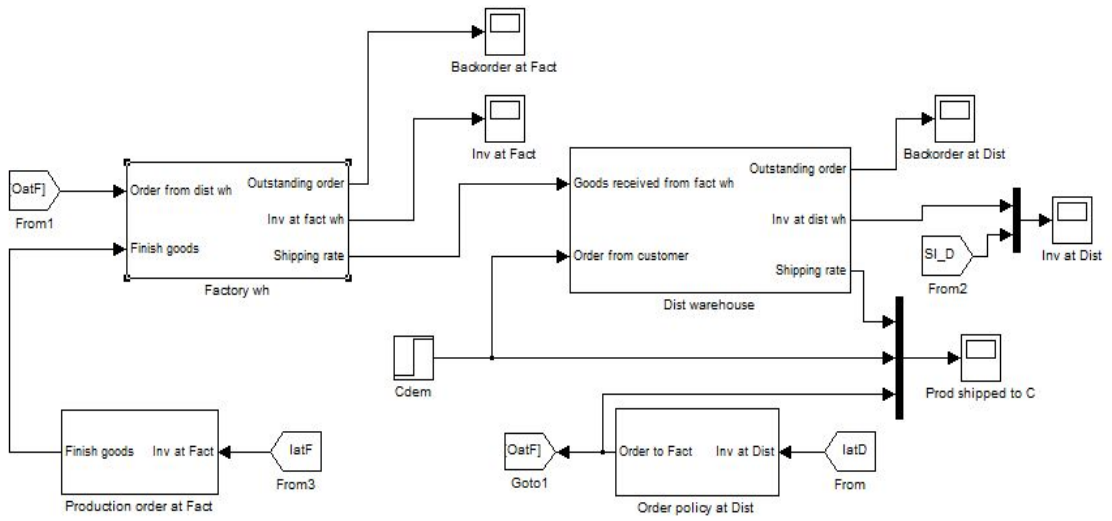

Figure 5-2: Simulink model of supply chain

5.2 Simulation results and analysis

5.2.1 Tracking target inventory level

The simulation results were depicted in figure 5-3 to 5-5. It is shown that in the case of proportional controller, inventory deficit cannot be recovered when customer demand changed. Figure 5-3 shows the dynamic behavior of inventory level at factory warehouse and distribution warehouse of supply chain in case of proportional controller. As depicted in the figure, actual inventory cannot recover to inventory target level.

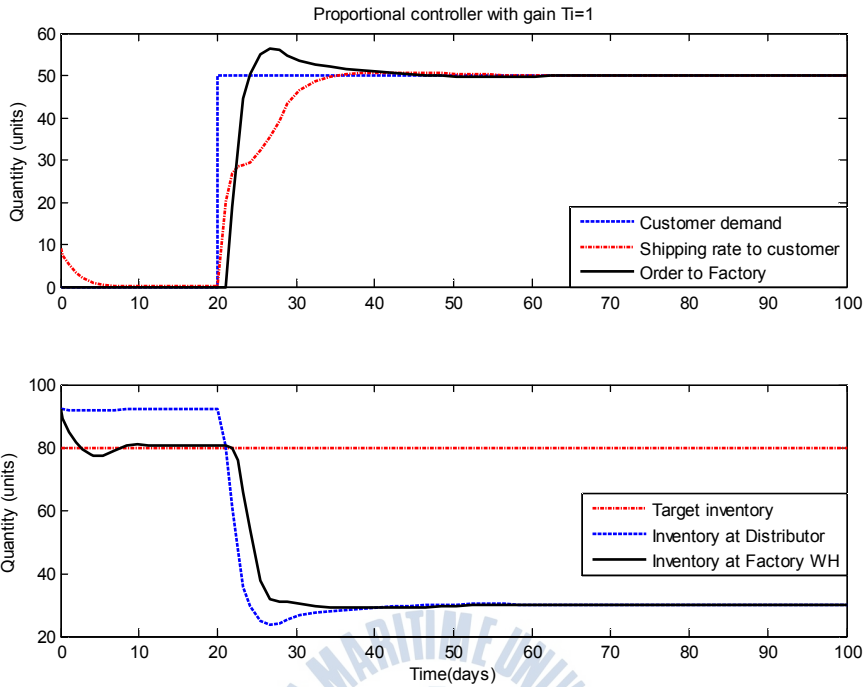

Figure 5-3: Dynamic response with proportional controller

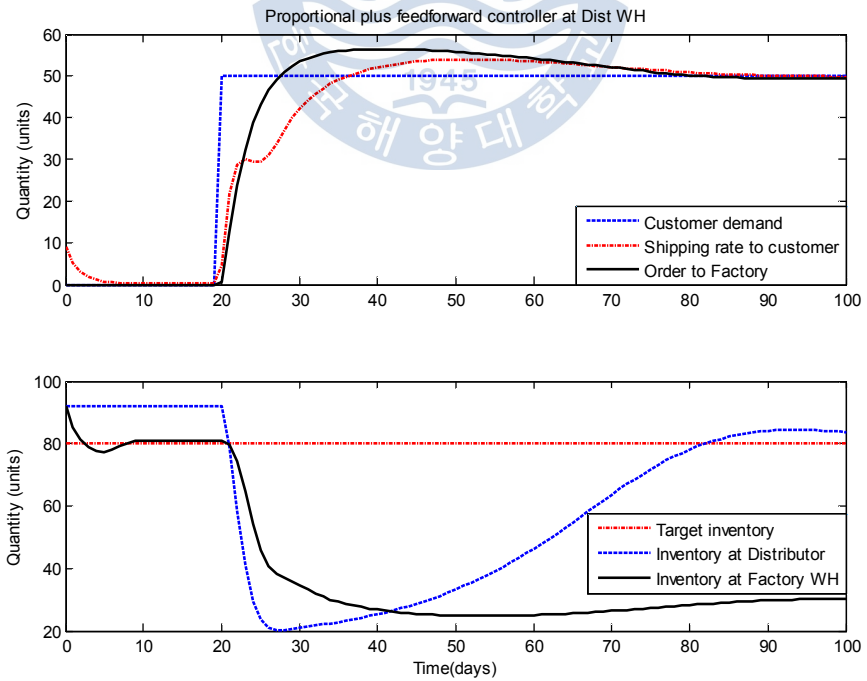

Figure 5-4: Dynamic response with proportional + FF controller

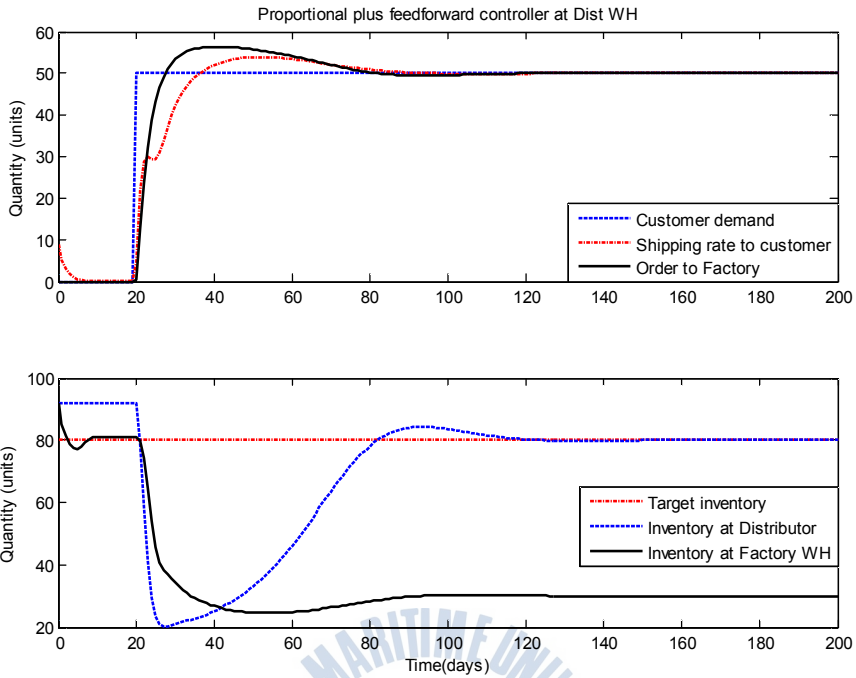

Figure 5-5: Dynamic response with proportional + FF controller (t=200)

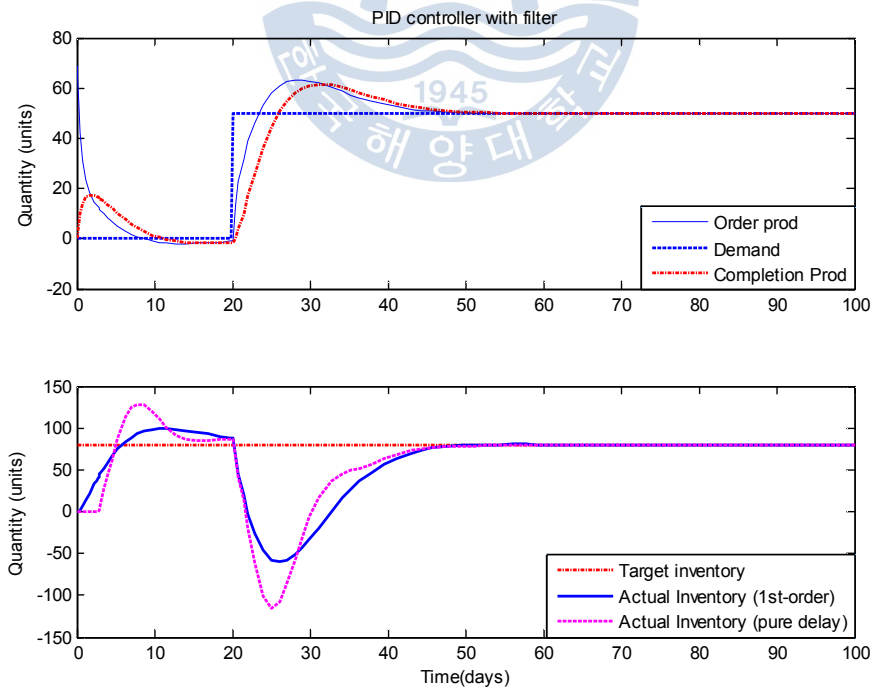

Figure 5-6: Dynamic response of factory warehouse with PID controller

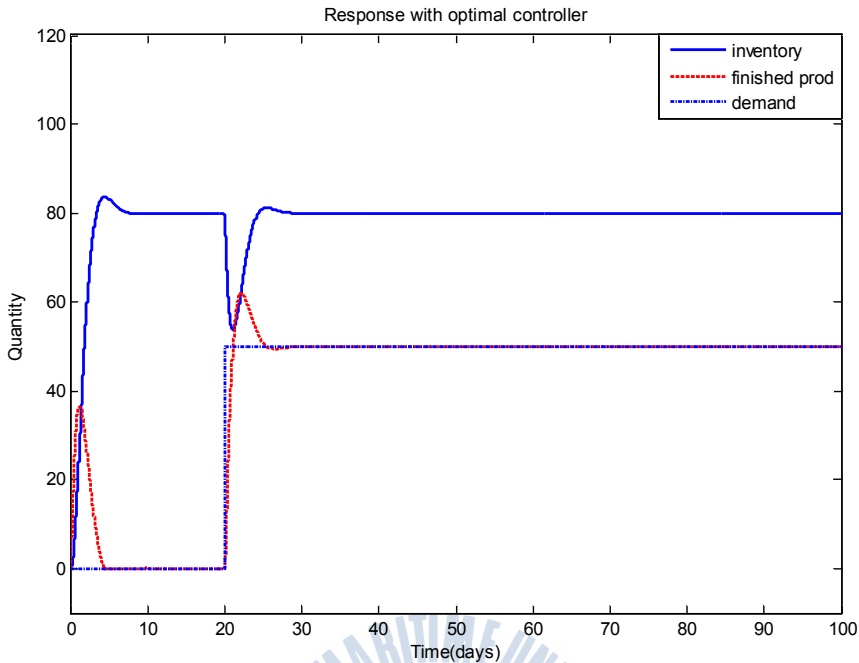

Figure 5-7: Dynamic response of factory warehouse with optimal controller

5.2.2 Costs measurement of supply chain

In this section, we will measure the average cost of supply chain, then we compare the average inventory level of each echelon as well as average cost between dynamic model and traditional inventory model such as EOQ. The following parameters are used to analyze the cost measurement of supply chain.

- Time period: 100 days
- Demand: 50 units/day
- Inventory holding cost: 0.2 \$/unit/day (or 20 \$/unit/100days)
- Ordering cost: 200 \$/order
- Production cost: 5 \$/unit

The economic order quantity can be found as

$$Q^* = \sqrt{\frac{2AD}{h}} = \sqrt{\frac{2.5000.200}{20}} = 316(\text{units})$$

where A , D , h , Q^* are fixed setup (ordering) cost, demand rate, inventory holding cost and economic order quantity, respectively. Obviously, the economic order quantity associated with fixed setup (ordering) cost, table 5-1 show the results with different ordering cost.

Table 5-1: EOQ model with different fixed cost

Fixed setup cost	Holding cost	Ordering cost	Total cost	Order quantity	Average inventory
150	2738.61	2738.61	5477.22	273.86	136.93
200	3162.28	3162.28	6324.56	316.23	158.11
250	3535.53	3535.53	7071.97	353.55	176.78
300	3872.98	3872.98	7745.97	387.30	193.65

Comparison between EOQ and dynamic model

Table 5-2: Comparison between EOQ and dynamic model (gain controller)

	EOQ model	Dynamic model (gain controller)	
		Distribution WH	Factory WH
Average inventory	136.93	31.3	32.64
Holding cost	2738.61	626.2	651.7
Ordering cost	2738.61		
Production cost			245.76
Total cost	5477.22	657.5	930.10

Table 5-3: Comparison between EOQ and dynamic model (gain + FF controller)

	EOQ model	Dynamic model (gain + FF controller)	
		Distribution WH	Factory WH
Average inventory	136.93	61.28	41.22
Holding cost	2738.61	1225.7	824.39
Ordering cost	2738.61		
Production cost			245.76
Total cost	5477.22	1286.98	930.10



Chapter 6. Conclusion

In this study, we have presented the dynamic methodology for modeling the supply chain. Based on system dynamics, the supply chain was modeled as the differential equations and synthesized to build the state-space model of whole supply chain. After modeling the supply chain dynamic, we proposed the controller to analysis and optimize the performance of supply chain. Then some numerical simulations were carried out to verify the controller. It is shown that the proposed controller can track the target inventory level better than traditional controller and also lead to reduce costs.

The limitation of this thesis is just shown the simulation results of inventory responses for factory warehouse. Meanwhile, we have to concern the inventory response of the other echelons. However, the simulation results for factory model also demonstrate the advantages of dynamic modeling method and application of control theory to model and control for supply chain. In the future, it is needed to continue developing the model and analysis for whole supply chain.

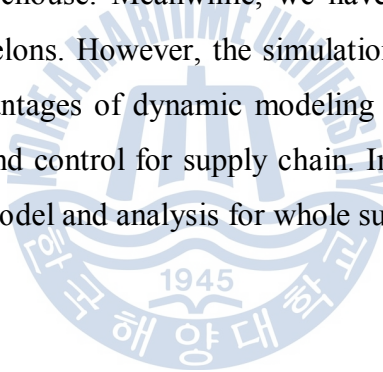

References

- [1] H. Sarimveis, P. Patrinos, C. D. Tarantilis, Ch. T. Kiranoudis, (2008) “Dynamic modeling and control of supply chain systems: A review”, *Journal of Computers and Operations Research*, Vol. 35, pp. 3530-3561.
- [2] B. M Beamon, (1998) “Supply chain design and analysis: models and methods”, *International Journal of Production Economics*, Vol.55, pp.281-294.
- [3] C. E. Riddalls, S. Bennett, N. S. Tipi, (2000) “Modeling the dynamics of supply chains”, *International Journal of Systems Science*, Vol.31, pp.969-976.
- [4] E. Perea, I. Grossmann, E. Ydstie, T. Tahmasebi, (2000) “Dynamic modeling and classical control theory for supply chain management”, *International Journal of Computers and Chemical Engineering*, Vol. 24, pp.1143-1149.
- [5] M. Ortega and L. Lin, (2004) “Control theory applications to the production-inventory problem”, *International Journal of Production and Research*, Vol. 42, pp.2303-2322.
- [6] Forrester, J. W. (1961) “*Industrial dynamics*”, Cambridge MA, USA: MIT press.
- [7] Towill, D. R. (1982) “Dynamic analysis of an inventory and order based production control system”, *International Journal of Production and Research*, Vol.20, pp.671-687.
- [8] Disney, S. M., Towill, D. R., (2003a) “On the bullwhip and the inventory variance produced by an ordering policy” *Omega* 31, pp.157-167.
- [9] Disney, S.M., Towill, D.R. (2003b) “The effect of vendor managed inventory(VMI) dynamics on the bullwhip effect in supply chains”, *International Journal of Production Economics*, Vol.85, pp.199-215.
- [10] Dejonckheere, J., Disney, S.M., Lambrecht, M.R., Towill, D.R.,(2003) “Measuring and avoiding the bullwhip effect: A control theoretic approach”, *European Journal Operational Research*, Vol. 147, pp.567-590.

- [11] Dejonckheere, J., Disney, S.M., Lambrecht, M.R., Towill, D.R., (2003) “The impact of information enrichment on the bullwhip effect in supply chains: A control engineering perspective”, *European Journal Operational Research*, Vol. 153, pp.727-750.
- [12] E. Perea, I. Grossmann, E. Ydstie, T. Tahmassebi, (2001) “Dynamic modeling and decentralized control of supply chains”, *Journal of Industrial Engineering Chemistry Research*, Vol. 404, pp 3369-3383.
- [13] E. Perea-Lopez, B. E. Ydstie, I. E. Grossmann, (2003) “A model predictive control strategy for supply chain optimization”, *International Journal of Computers and Chemical Engineering*, Vol. 27, pp.1201-1218.
- [14] J. J. Coyle, E. J. Bardi, C. J. Langley Jr., (2003) “The management of Business Logistics: A supply chain perspective”, 7th ed., South-Western.
- [15] www.cscmp.org
- [16] www.rockfordconsulting.com/supply-chain-management.htm
- [17] R. H. Ballou, (1999) “Business Logistics Management”, 4th ed., Prentice-Hall.
- [18] Douglas M. Lambert, (2008) “An executive summary of Supply chain management: Process, Partnerships, Performance”, Supply Chain Management Institute.
- [19] M. P. Groove, (2008) “Automation, production systems, and computer-integrated Manufacturing”, 3rd ed., Prentice-Hall.
- [20] J. D. Schwartz, D. E. Rivera, 2010 “A process control approach to tactical inventory management in production-inventory systems”, *International Journal of Production Economics*, Vol.125, pp.111-124.
- [21] F. L. Lewis (1995) “Optimal control”, 2nd ed., John Wiley and Sons.